

IN-WALL TABLES & BENCHES

DRM / DSM SERIES

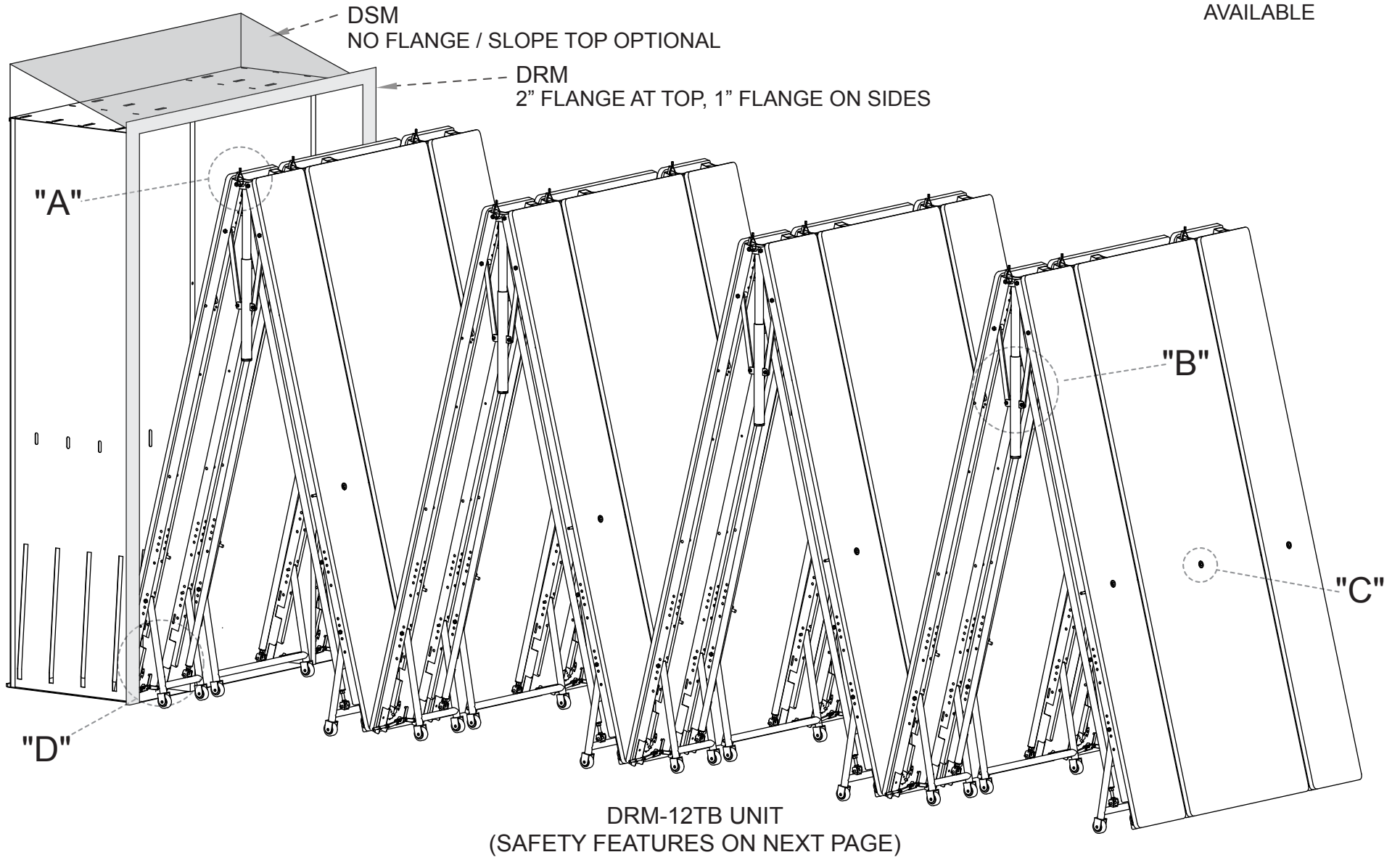

ADA MODELS
 AVAILABLE



RECESSED/SURFACE SERIES SPECS

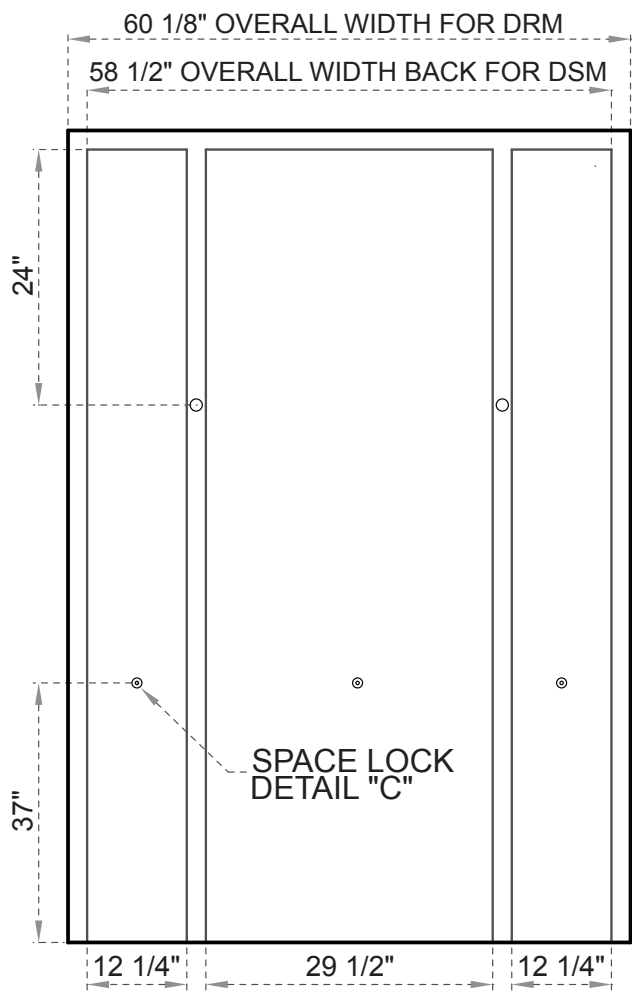

FRONT ELEVATION

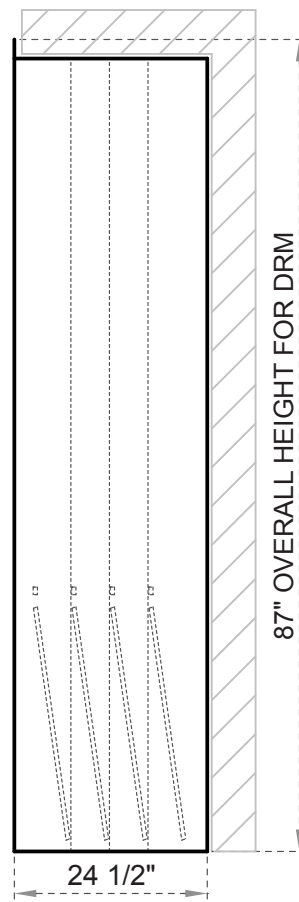

VERTICAL SECTION
 DRM-12TB MODEL

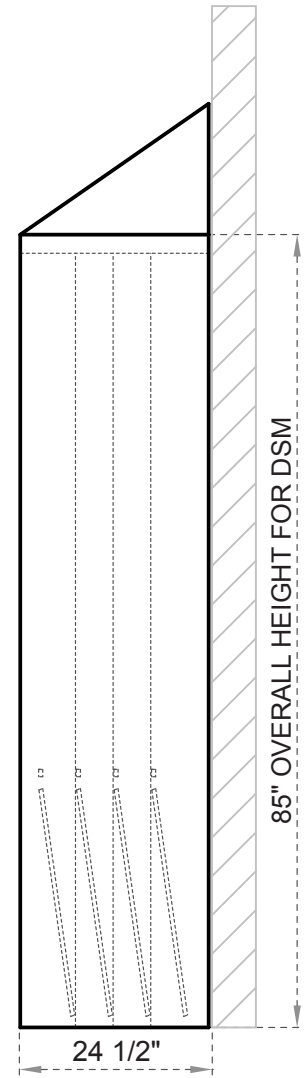

VERTICAL SECTION
 DSM-12TB MODEL

TABLE SELECTION CHART (OUR TABLES COME IN 10', 12' AND 14' LENGTHS)

R- Recess S-Surface	RECESS MOUNT DIM.			SURFACE MOUNT DIM.			# of TABLES & BENCHES PER UNIT
	width	height	depth	width	height	depth	
D_M-3TB Unit	59.5"	85.5"	6.25"	58.5"	87"	6"	
D_M-6TB Unit	59.5"	85.5"	12.25"	58.5"	87"	12"	
D_M-9TB Unit	59.5"	85.5"	18.25"	58.5"	87"	18"	
D_M-12TB Unit	59.5"	85.5"	24.25"	58.5"	87"	24"	

IN-WALL TABLES & BENCHES DRM / DSM SERIES

AT NELSON ADAMS, SAFETY IS OUR MAIN PRIORITY. WE HAVE INNOVATED OUR IN-WALL SYSTEMS TO A SAFETY STANDARD NOT OFFERED BY OUR COMPETITION. BY CHOOSING OUR PRODUCT YOU CAN RELY ON QUALITY AND SAFETY IN YOUR CAFETERIA SETTING.

SAFETY FEATURES

(A) LOCK IN CASE

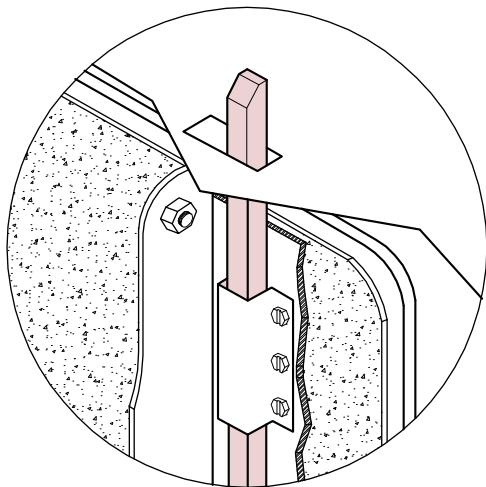

(B) TABLE LOCK FOR EASY MOVEMENT

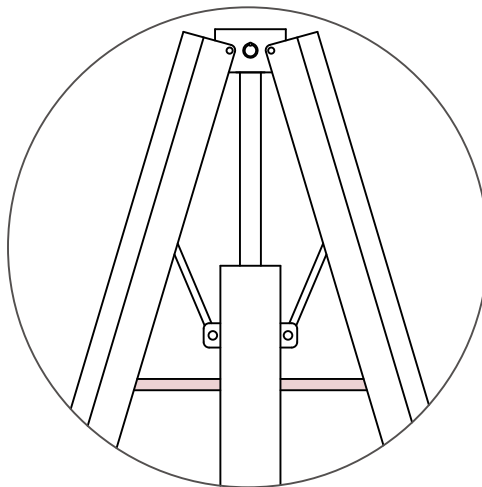

(C) KNOX TABLE LOCK

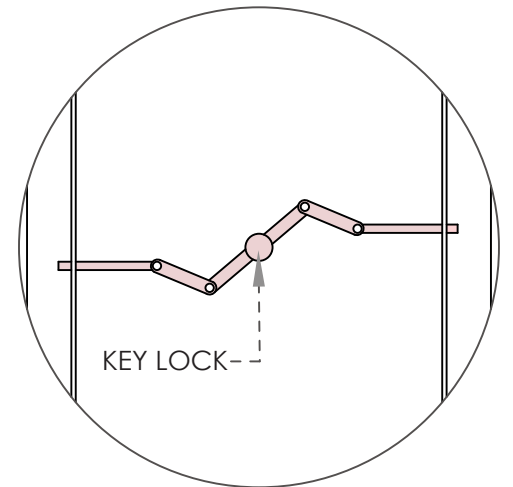

(D) TABLE SAFETY LOCK

OUR NEW LOCKING SYSTEM FEATURES;
 AUTOMATIC SPRING LOADED LOCKING PINS SECURE OUR TABLES
 & BENCHES WHILE IN STORAGE TO AVOID UNNECESSARY ACCIDENTS.
 CONTACT US TO LEARN MORE ABOUT OUR SAFETY INNOVATIONS.

